

# ELEKTROSTANDARD®

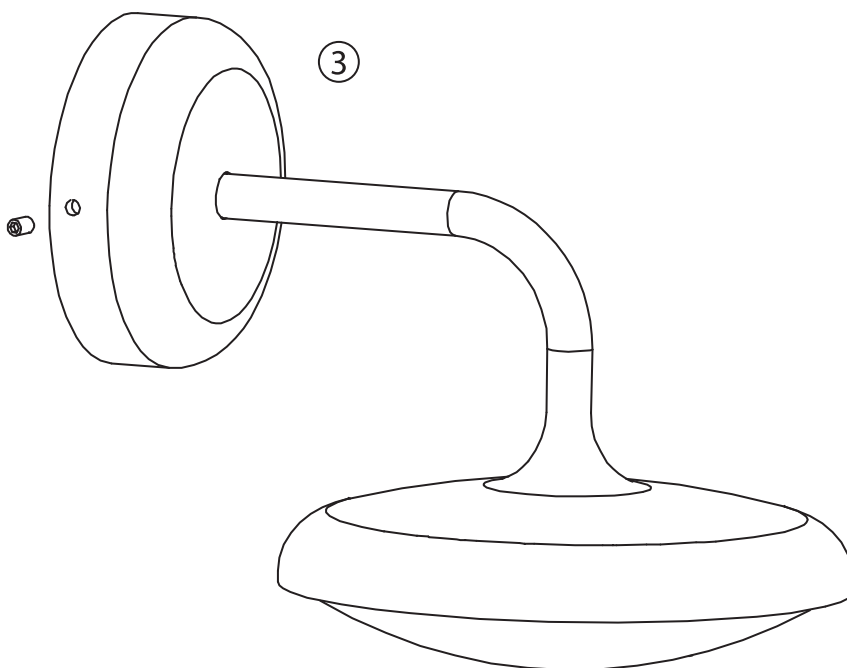

**35162/D**

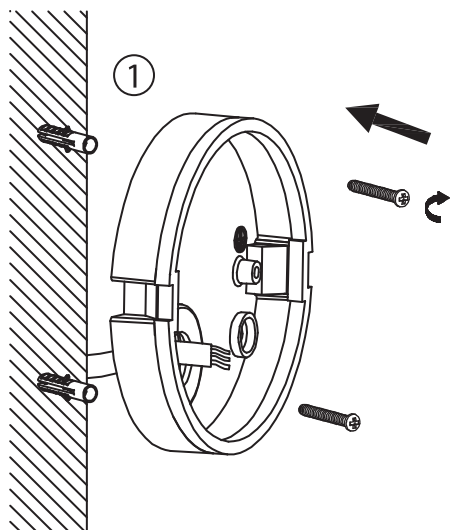
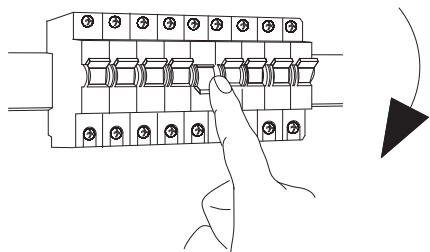